

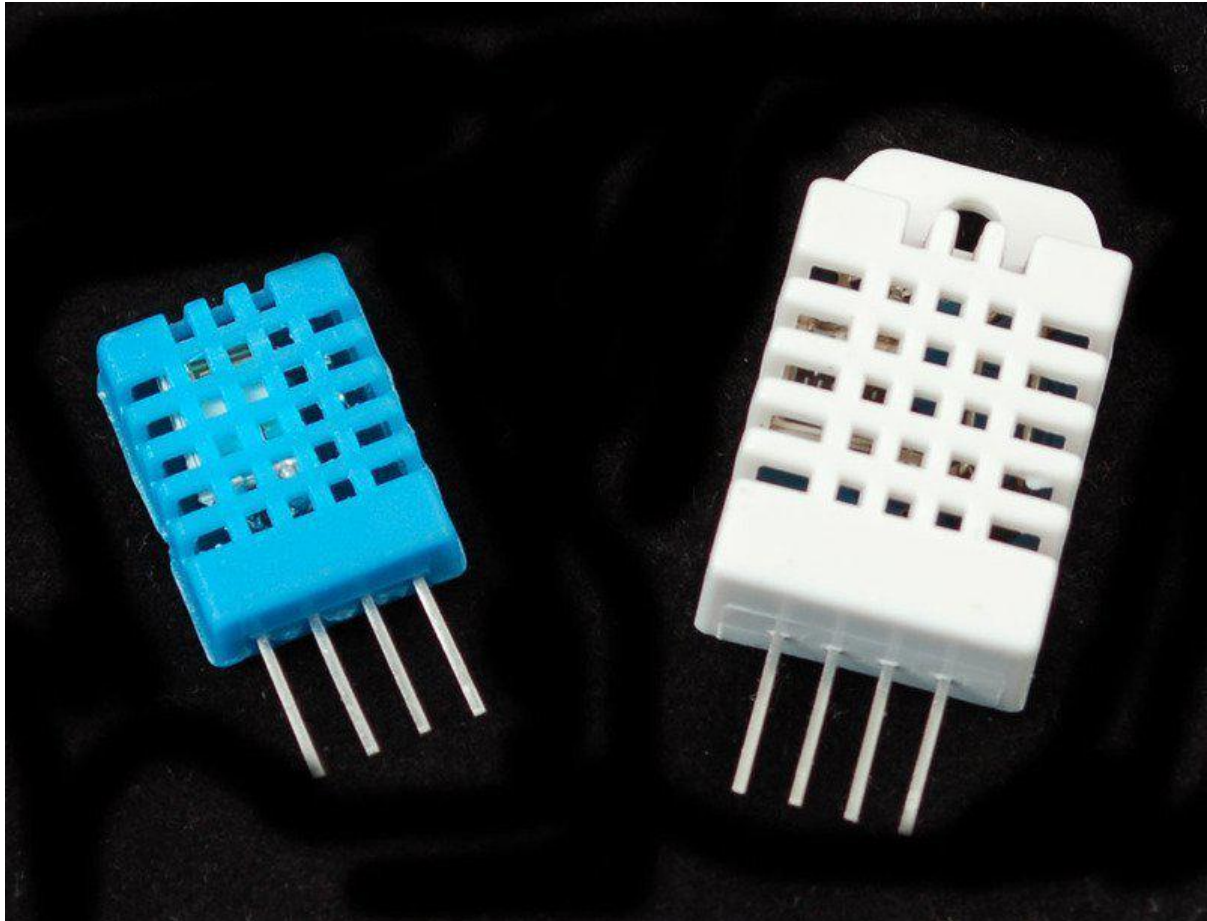

DHT11, DHT22 and AM2302 Sensors

Created by lady ada



<https://learn.adafruit.com/dht>

Last updated on 2021-12-13 12:38:56 PM EST

Table of Contents

Overview	3
• DHT11 vs DHT22	3
Connecting to a DHTxx Sensor	4
Using a DHTxx Sensor	6
DHT CircuitPython Code	8
• Adafruit CircuitPython Module Install	8
• Wiring	9
• Usage	10
• Example Code	12
Python Docs	12
Downloads	13
• Simulator	13

Overview

This tutorial covers the low cost [DHT temperature & humidity sensors \(https://adafru.it/aJU\)](https://adafru.it/aJU). These sensors are very basic and slow, but are great for hobbyists who want to do some basic data logging. The DHT sensors are made of two parts, a capacitive humidity sensor and a [thermistor \(https://adafru.it/aHD\)](https://adafru.it/aHD). There is also a very basic chip inside that does some analog to digital conversion and spits out a digital signal with the temperature and humidity. The digital signal is fairly easy to read using any microcontroller.

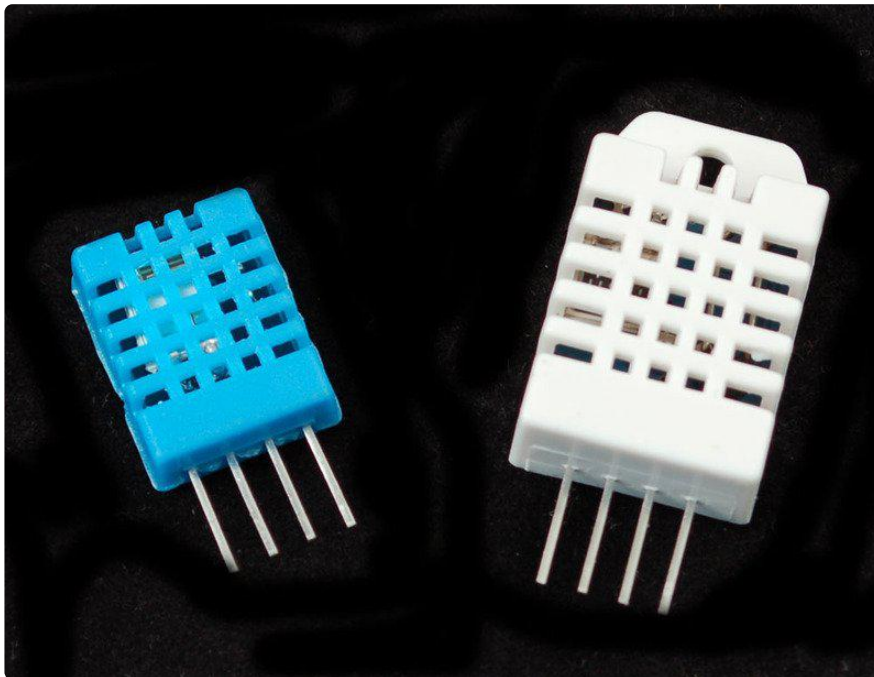

DHT11 vs DHT22

We have two versions of the DHT sensor, they look a bit similar and have the same pinout, but have different characteristics. Here are the specs:

[DHT11 \(http://adafru.it/386\)](http://adafru.it/386)

- Ultra low cost
- 3 to 5V power and I/O
- 2.5mA max current use during conversion (while requesting data)
- Good for 20-80% humidity readings with 5% accuracy
- Good for 0-50°C temperature readings $\pm 2^\circ\text{C}$ accuracy
- No more than 1 Hz sampling rate (once every second)
- Body size 15.5mm x 12mm x 5.5mm
- 4 pins with 0.1" spacing

[DHT22 \(http://adafru.it/385\)](http://adafru.it/385)/ [AM2302 \(https://adafru.it/uF2\)](https://adafru.it/uF2) (Wired version)

- Low cost
- 3 to 5V power and I/O
- 2.5mA max current use during conversion (while requesting data)
- Good for 0-100% humidity readings with 2-5% accuracy
- Good for -40 to 80°C temperature readings $\pm 0.5^\circ\text{C}$ accuracy
- No more than 0.5 Hz sampling rate (once every 2 seconds)
- Body size 15.1mm x 25mm x 7.7mm
- 4 pins with 0.1" spacing

As you can see, the [DHT22 \(http://adafru.it/385\)](http://adafru.it/385) / [AM2302 \(https://adafru.it/uF2\)](https://adafru.it/uF2) is a little more accurate and good over a slightly larger range. Both use a single digital pin and are 'sluggish' in that you can't query them more than once every second or two.

You can pick up both the [DHT11 \(http://adafru.it/386\)](http://adafru.it/386) and [DHT22 \(http://adafru.it/385\)](http://adafru.it/385) or [AM2302 \(https://adafru.it/uF2\)](https://adafru.it/uF2) from the adafruit shop!

Connecting to a DHTxx Sensor

Luckily it is trivial to connect to these sensors, they have fairly long 0.1"-pitch pins so you can plug them into any breadboard, perfboard or similar.

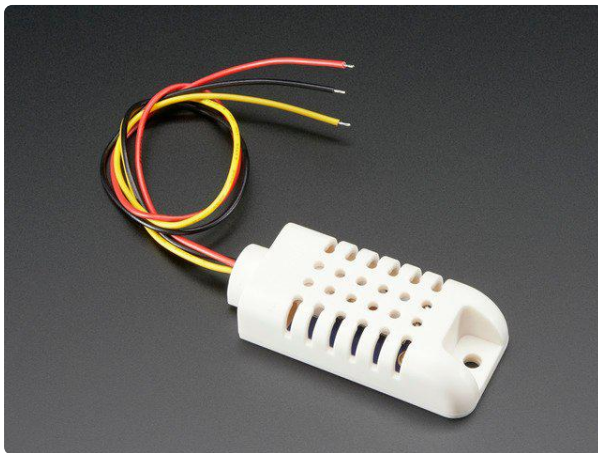
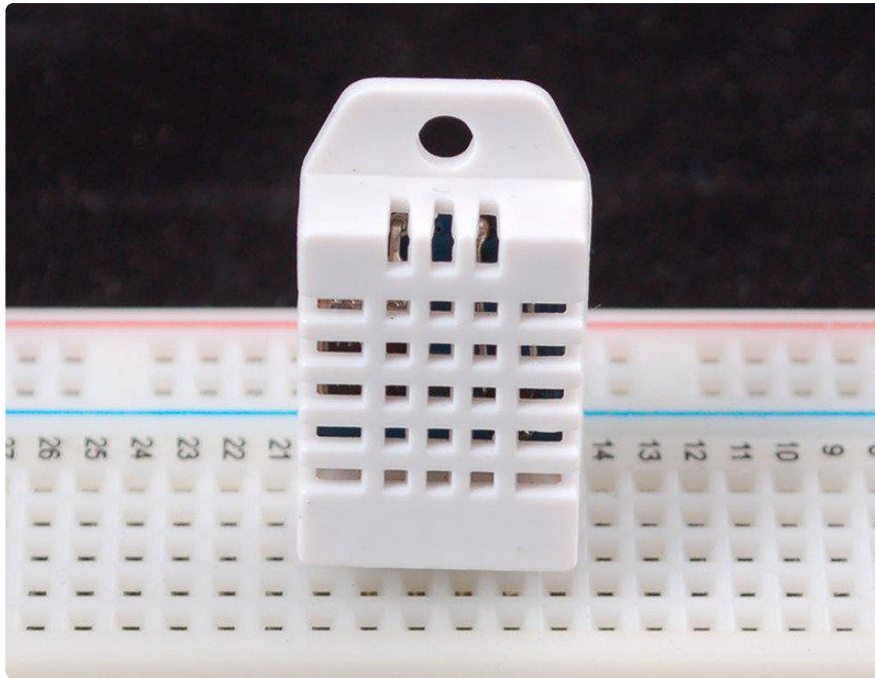

AM2302 (wired DHT22) temperature-humidity sensor

The AM2302 is a wired version of the DHT22, in a large plastic body. It is a basic, low-cost digital temperature and humidity sensor....

<https://www.adafruit.com/product/393>

Likewise, it is fairly easy to connect up to the DHT sensors. They have four pins

1. VCC - red wire Connect to 3.3 - 5V power. Sometime 3.3V power isn't enough in which case try 5V power.
2. Data out - white or yellow wire
3. Not connected
4. Ground - black wire

Simply ignore pin 3, its not used. You will want to place a 10 Kohm resistor between VCC and the data pin, to act as a medium-strength pull up on the data line. The Arduino has built in pullups you can turn on but they're very weak, about 20-50K

DHT22 and AM2302 often have a pullup already inside, but it doesn't hurt to add another one!

This diagram shows how we will connect for the testing sketch. Connect data to pin 2, you can change it later to any pin.

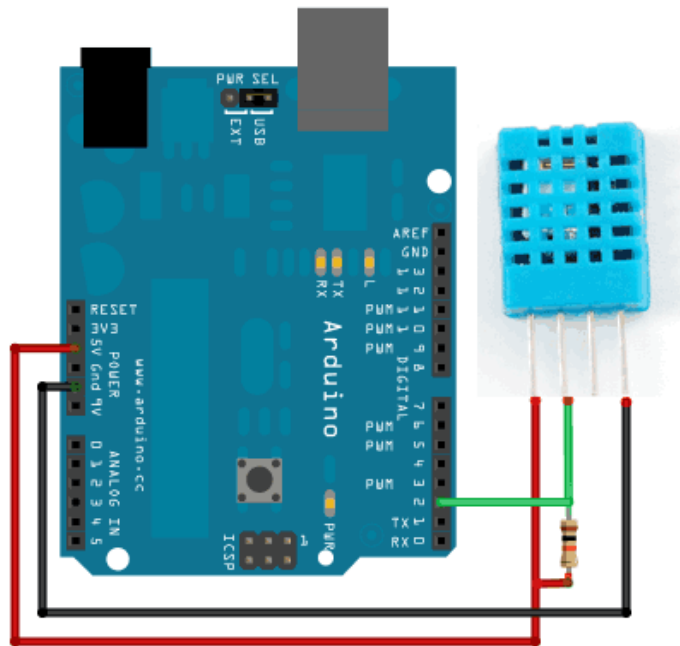

If you have an AM2302

Using a DHTxx Sensor

To test the sketch, we'll use an Arduino. You can use any microcontroller that can do microsecond timing, but since its a little tricky to code it up, we suggest verifying the wiring and sensor work with an Arduino to start.

You should have the [Arduino IDE \(https://adafru.it/fvm\)](https://adafru.it/fvm) software running at this time. Next it's necessary to install our DHT library, which can be done though the Arduino Library Manager:

Sketch→Include Library→Manage Libraries...

Enter “dht” in the search field and look through the list for “DHT sensor library by Adafruit.” Click the “Install” button, or “Update” from an earlier version.

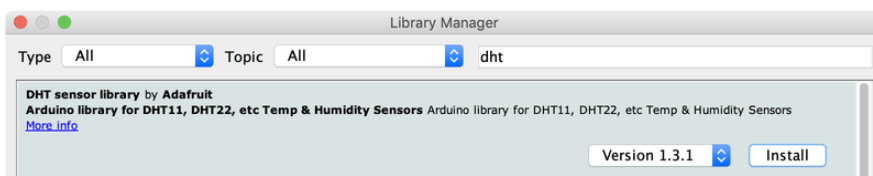

IMPORTANT: As of version 1.3.0 of the DHT library you will also need to install the Adafruit Unified Sensor library, which is also available in the Arduino Library Manager:

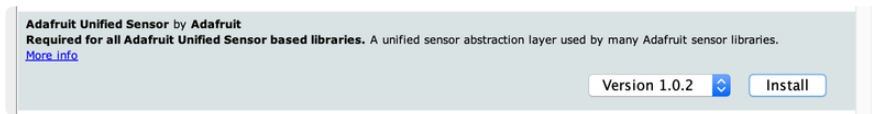

Now load up the Examples→DHT→DHTtester sketch

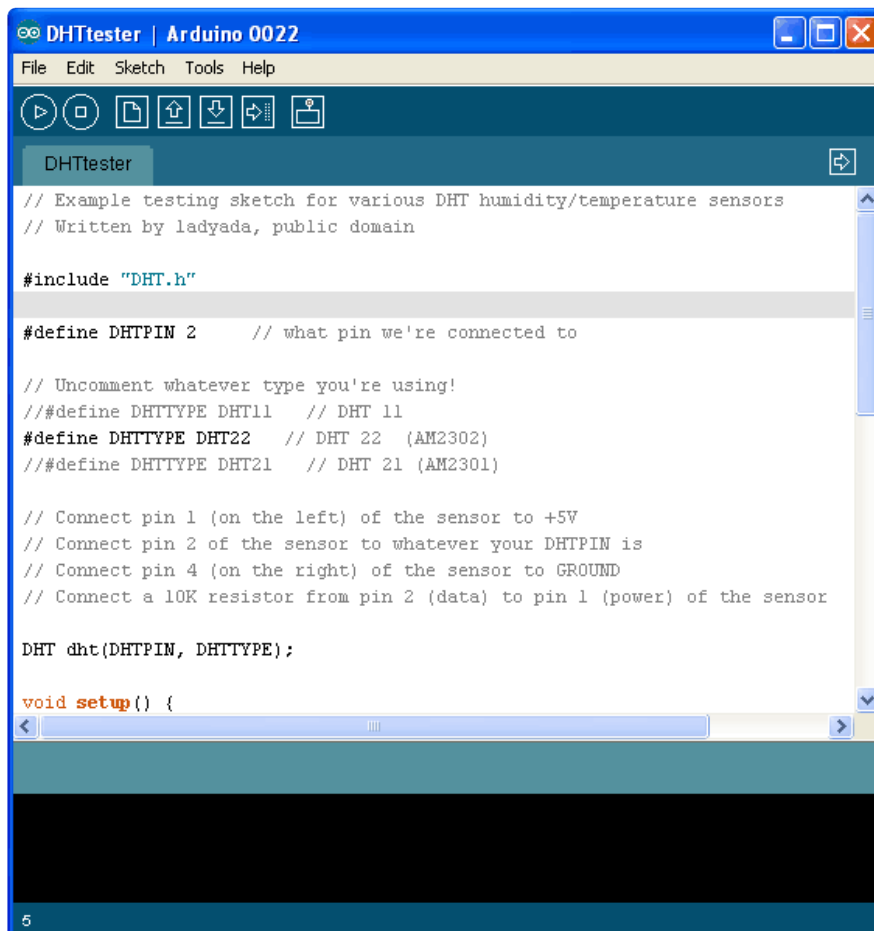

If you're using a DHT11 sensor, comment out the line that sets the type:

```
///define DHTTYPE DHT22 // DHT 22 (AM2302)
```

and uncomment the line that says:

```
#define DHTTYPE DHT11 // DHT 11
```

This will make the data appear correctly for the correct sensor. Upload the sketch!

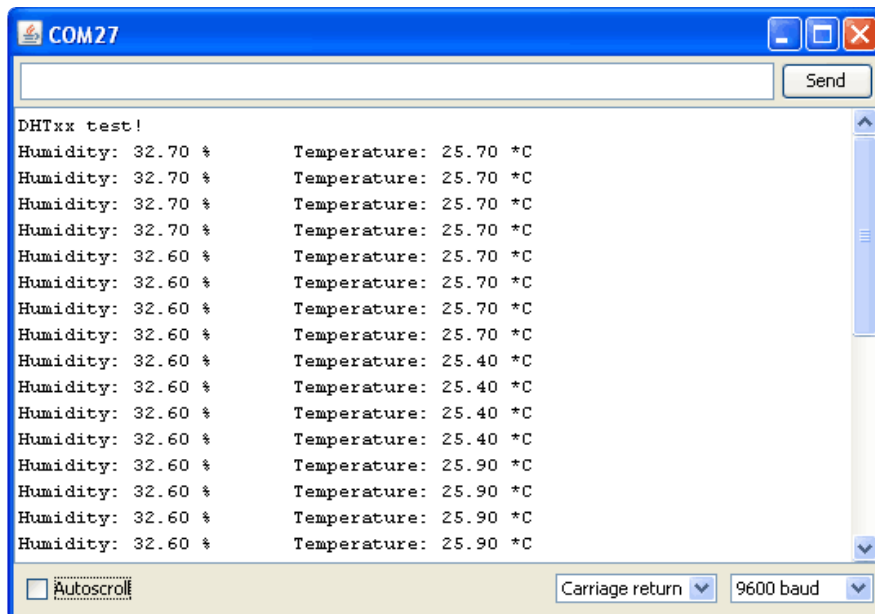

You should see the temperature and humidity. You can see changes by breathing onto the sensor (like you would to fog up a window) which should increase the humidity.

You can add as many DHT sensors as you line on individual pins, just add new lines such as

```
DHT dht2 = DHT(pin, type);
```

below the declaration for the initial `dht` object, and you can reference the new `dht2` whenever you like.

DHT CircuitPython Code

This library uses the `pulseio` module in CircuitPython. As of CircuitPython 7.0.0, `pulseio` is no longer available on the smallest CircuitPython builds, such as the Trinket M0, Gemma M0, and Feather M0 Basic boards. You can substitute a more modern sensor, which will work better as well. See the guide [Modern Replacements for DHT11 and DHT22 Sensors \(https://learn.adafruit.com/modern-replacements-for-dht11-dht22-sensors\)](https://learn.adafruit.com/modern-replacements-for-dht11-dht22-sensors) for suggestions.

Adafruit CircuitPython Module Install

To use the DHT sensor with your Adafruit CircuitPython board you'll need to install the [Adafruit_CircuitPython_DHT \(https://adafru.it/Beq\)](https://adafru.it/Beq) module on your board.

First make sure you are running the [latest version of Adafruit CircuitPython \(https://adafru.it/Em8\)](https://adafru.it/Em8) for your board.

Next you'll need to install the necessary libraries to use the hardware--carefully follow the steps to find and install these libraries from [Adafruit's CircuitPython library bundle \(https://adafru.it/zdx\)](https://adafru.it/zdx). Our introduction guide has [a great page on how to install the library bundle \(https://adafru.it/ABU\)](https://adafru.it/ABU) for both express and non-express boards.

Remember for non-express boards like the, you'll need to manually install the necessary libraries from the bundle:

- adafruit_dht.mpy

You can also download the adafruit_dht.mpy from [its releases page on Github \(https://adafru.it/Ber\)](https://adafru.it/Ber).

Before continuing make sure your board's lib folder or root filesystem has the adafruit_dht.mpy module copied over.

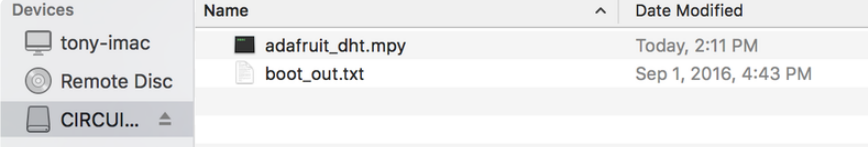

Devices	Name	Date Modified
tony-imac	adafruit_dht.mpy	Today, 2:11 PM
Remote Disc	boot_out.txt	Sep 1, 2016, 4:43 PM
CIRCUI...		

Wiring

DHT wiring is very simple:

- The left-most pin is power. We recommend powering from 5V (sometimes 3V is not enough) - this is OK even if you are using 3.3V logic
- The second pin is data. Connect a 10K pullup resistor from this pin to 3.3V. If you are using a DHT11 it's required. If you're using a DHT22 or AM2302 you can sometimes leave this off
- Skip the third pin
- The right-most pin is ground

For the DATA pin you must pick a pin that has PWM support (pulseio) - Check the board's guide for what pins have timers available

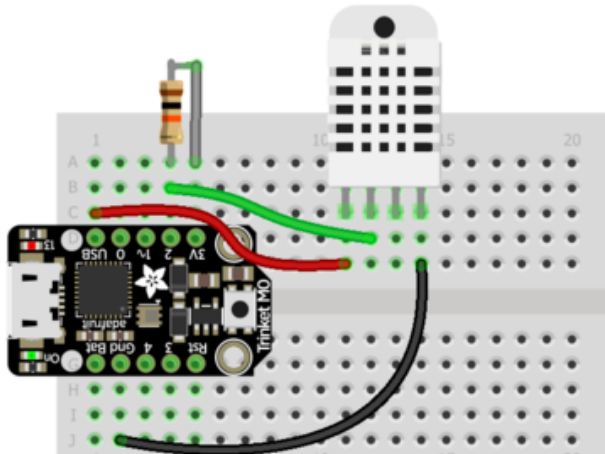

Here's an example using a Trinket M0 - you can use any CircuitPython board, just check that the Data pin is `pulseio`-capable.

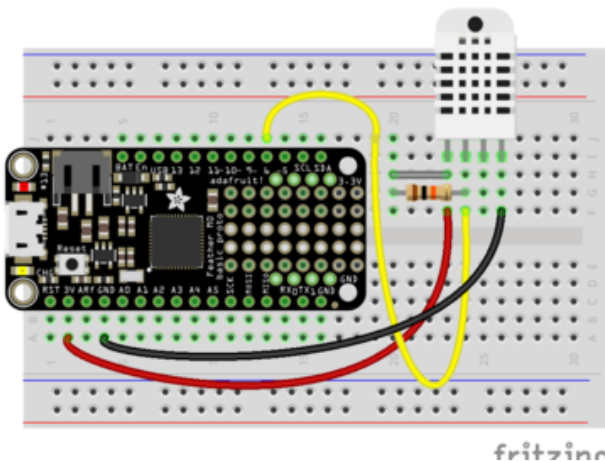

In this example we'll use a Feather M0 and DHT22 sensor connected to pin D6

Fritzing Source

<https://adafru.it/A0o>

Usage

To demonstrate the usage of the DHT sensor module you can connect to your board's serial REPL and run Python code to read the temperature and humidity.

Next [connect to the board's serial REPL \(https://adafru.it/Awz\)](https://adafru.it/Awz) so you are at the CircuitPython >>> prompt.

Next import the board and adafruit_dht modules, these are necessary modules to initialize and access the sensor:

```
import board
import adafruit_dht
```

You may also want to try powering the DHT sensor from 5V (we found sometimes it really needs more power) but still having the 10K pull-up resistor to 3.3V volts)

Now create an instance of either the DHT11 or DHT22 class, depending on the type of sensor you're using (for the AM2302 sensor use the DHT22 class). You must pass in the pin which is connected to the signal line, for example a DHT22 or AM2302 sensor connected to board pin **D6** would need this code:

```
dht = adafruit_dht.DHT22(board.D6)
```

Note for a DHT11 sensor you'd instead use `adafruit_dht.DHT11` in place of the `adafruit_dht.DHT22` code above.

At this point you're all set and ready to start reading the temperature and humidity! You can do this by reading the temperature property which returns temperature in degrees Celsius:

```
dht.temperature
```

```
>>> dht.temperature
22.2
>>>
```

To read the humidity grab the value of the humidity property, it will return the percent humidity as a floating point value from 0 to 100%:

```
dht.humidity
```

```
>>> dht.humidity
53.2
>>>
```

In most cases you'll always get back a temperature or humidity value when requested, but sometimes if there's electrical noise or the signal was interrupted in some way you might see an exception thrown to try again. It's normal for these sensors to sometimes be hard to read and you might need to make your code retry a few times if it fails to read. However if you always get errors and can't ever read the sensor then double check your wiring (don't forget the pull-up resistor if needed!) and the power to the device.

Example Code

Here's a full example sketch which also manages error-retry logic (which will happen once in a while).

Don't forget to change the logic pin to whatever pin you're using! Then save this as `main.py` on your CircuitPython board

```
import time

import adafruit_dht
import board

dht = adafruit_dht.DHT22(board.D2)

while True:
    try:
        temperature = dht.temperature
        humidity = dht.humidity
        # Print what we got to the REPL
        print("Temp: {:.1f} *C \t Humidity: {}%".format(temperature, humidity))
    except RuntimeError as e:
        # Reading doesn't always work! Just print error and we'll try again
        print("Reading from DHT failure: ", e.args)

    time.sleep(1)
```

If you are using a DHT11, change the code to use a `adafruit_dht.DHT11(board.D2)` object.

Open the REPL to see the output! Breathe on the sensor to see it move temperature and humidity up (unless you are a White Walker in which case the temperature will go down)

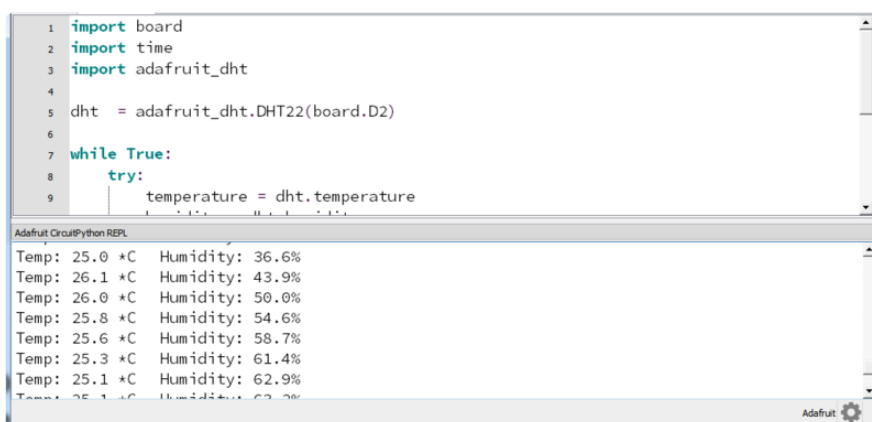

The screenshot shows a code editor window with the following code:

```
1 import board
2 import time
3 import adafruit_dht
4
5 dht = adafruit_dht.DHT22(board.D2)
6
7 while True:
8     try:
9         temperature = dht.temperature
```

Below the code editor is the REPL output window, which displays the following data:

```
Temp: 25.0 *C Humidity: 36.6%
Temp: 26.1 *C Humidity: 43.9%
Temp: 26.0 *C Humidity: 50.0%
Temp: 25.8 *C Humidity: 54.6%
Temp: 25.6 *C Humidity: 58.7%
Temp: 25.3 *C Humidity: 61.4%
Temp: 25.1 *C Humidity: 62.9%
```

Python Docs

[Python Docs \(https://adafru.it/C4a\)](https://adafru.it/C4a)

Downloads

- [Arduino library and example code for DHT sensors](https://adafru.it/aJX) (https://adafru.it/aJX)
- [Adafruit_Sensor library](https://adafru.it/aZm) (https://adafru.it/aZm) (required by the DHT library above)
- [DHT11 datasheet](https://adafru.it/aJY) (https://adafru.it/aJY)(in chinese, so see the DHT22 datasheet too!)
- [DHT22 datasheet](https://adafru.it/aJZ) (https://adafru.it/aJZ)
- [K&R Smith calibration notes](https://adafru.it/BfU) (https://adafru.it/BfU)

Simulator

You can try out a [DHT simulator by Wowki](https://adafru.it/N8B) (https://adafru.it/N8B) here: <https://wokwi.com/arduino/libraries/DHT-sensor-library> (https://adafru.it/Ncg)

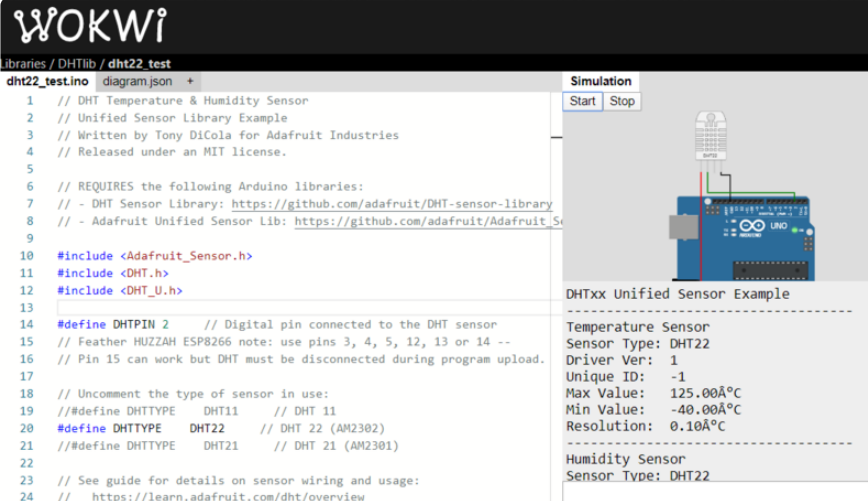

The screenshot shows the Wokwi simulator interface. On the left is a code editor for a file named 'dht22_test.ino'. The code includes comments and preprocessor directives for a DHT sensor example. On the right is a simulation window titled 'Simulation' with 'Start' and 'Stop' buttons. Below the buttons is a 3D model of an Arduino board with a DHT sensor module connected. Below the model is a text box titled 'DHTxx Unified Sensor Example' which displays sensor data:

```
Temperature Sensor
Sensor Type: DHT22
Driver Ver: 1
Unique ID: -1
Max Value: 125.00Å°C
Min Value: -40.00Å°C
Resolution: 0.10Å°C

Humidity Sensor
Sensor Type: DHT22
```